

MACH 50 MAINTENANCE SHEET - HOW TO ASSEMBLE



- ①
- ②
- ③
- ④
- ⑤
- ⑥
- ⑦
- ⑧
- ⑨
- ⑩
- ⑪
- ⑫
- ⑬
- ⑭
- ⑮
- ⑯
- ⑰
- ⑱

A. Before assembly ensure that all components are cleaned, greased and lubricated. Lay out components in the order of the illustration above for ease of identification.



B. Secure Cylinder (13) on a bench or suitable stripping equipment. The cylinder is not reversible and the bottom of the hammer is the cylinder end where the internal snap ring groove is nearest the cylinder threads, The top of the hammer is cylinder end with machined flats.

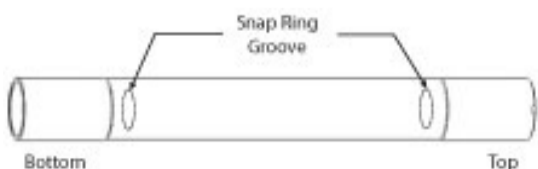

C. Insert Snap Ring (14) into bottom of Cylinder (13). Ensure that it sits in the snap ring groove.



D. Insert Spacer (15) into the bottom of Cylinder (13). Ensure it sits fully up against the Snap Ring (14).

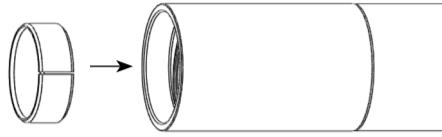

E. Grease splines and fit Chuck (18) over the Drill Bit.

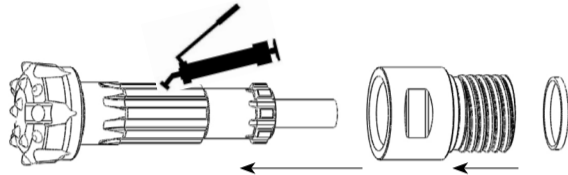

F. Fit Chuck Spacer (17) over Chuck (18) and place the Bit Retaining Ring (16) over the Drill Bit.

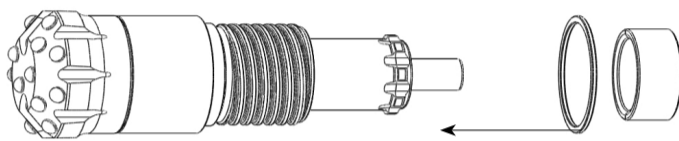

G. Grease threads and screw the Drill Bit, Chuck (18), Chuck Spacer (17) and Bit Retaining Ring (16) into the bottom of the Cylinder (13) until fully tightened.

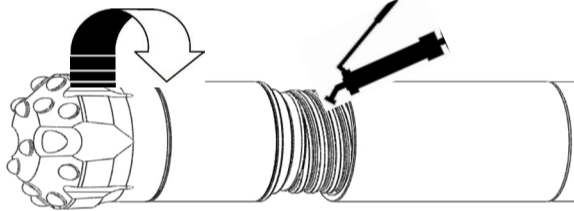

H. Coat Piston (14) liberally with rock oil - minimum 200 centistroke and insert into the top of the Cylinder (13). Ensure that the Piston is inserted the right way around - as illustrated below.

Top of Cylinder

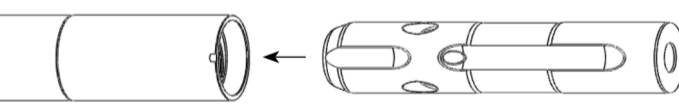

I. Insert the Snap Ring (14) into the top of the Cylinder (13). Ensure it seats in the snap ring groove.

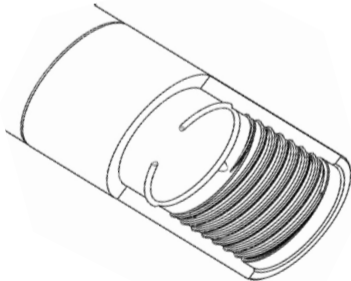

J. Fit the 'O' Ring (10) onto the Air Distributor (9) and place onto the top of the Cylinder (13) so that it seats up against the top Snap Ring (11).



SETTING CORRECT TOLERANCES

K. Fit Make Up Ring (8) onto lower end of N.R.V. Finger (6) along with existing and additional Shims (7).

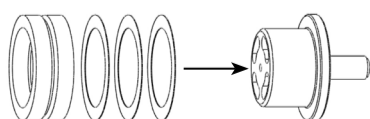

L. Insert N.R.V Finger (6), Compression Ring (8) and Shim (7) into top of Cylinder (13).

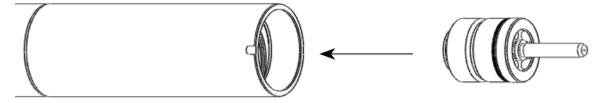

M. Screw the Top Adaptor (2) into the top of the Cylinder (13) and hand tighten.

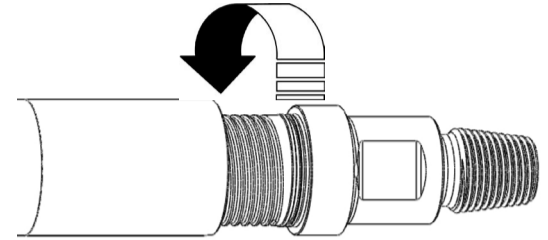

N. Measure make up gap 'X' between Cylinder (13) and Top Adaptor (2). Correct gap should be 2.0 - 3.00 mm (0.098-0.118").

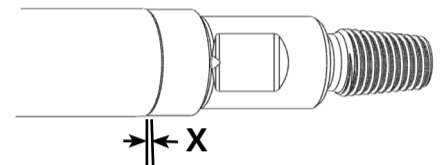

O. Unscrew and remove Top Adaptor (2), N.R.V. Finger (6), Shims (7) and Make Up Ring (8) from Cylinder (13). Replace Shims to ensure that make up gap 'X' falls between min and max figures.

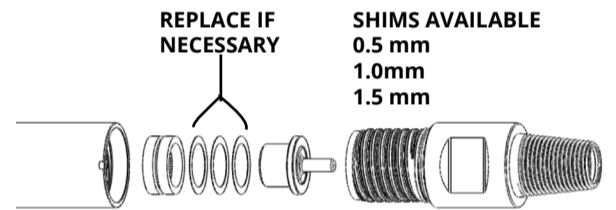

FINAL ASSEMBLY

P. Fit Compression Spring (8) necessary Shim (7) and N.R.V. Assembly (4-5) onto N.R.V. Finger (6) and insert into top of Cylinder (13).

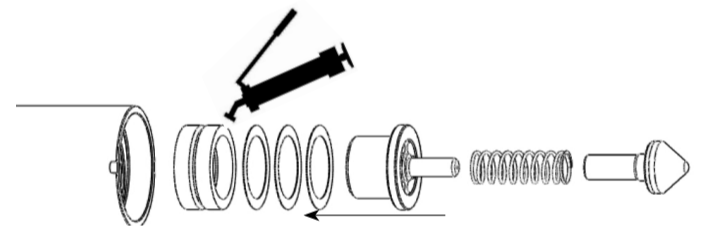

Q. Fit 'O' Ring (3) onto Top Adaptor (2).

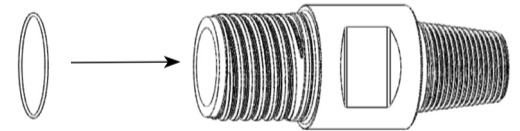

R. Grease threads and screw Top Adaptor (2) into Cylinder (13) until fully tightened.

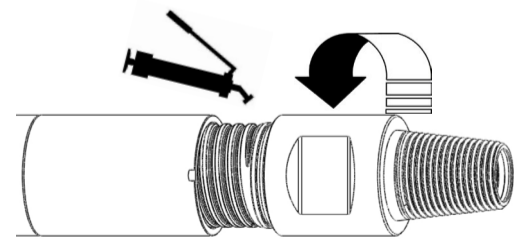

S. Depress N.R.V (4) and pour 1/3 litre of air line oil into the hammer.

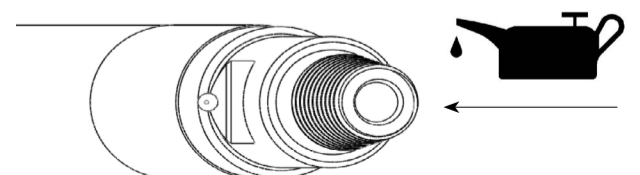

If you need further assistance, please call us on:
(0)1422 399900 or email salesuk@halcorocktools.com

HAJCO
Rock Tools

MACH 50 MAINTENANCE SHEET - HOW TO DISMANTLE

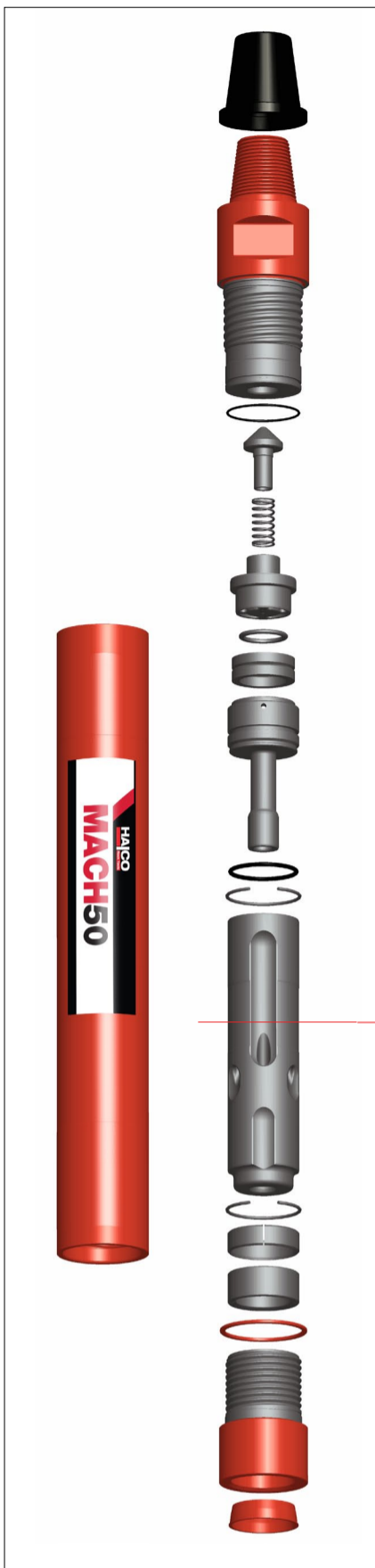

- ①
- ②
- ③
- ④
- ⑤
- ⑥
- ⑦
- ⑧
- ⑨
- ⑩
- ⑪
- ⑫
- ⑬
- ⑭
- ⑮
- ⑯
- ⑰
- ⑱

B. Break the top joint between Cylinder (13) and Top Adaptor (2) and bottom joint between Cylinder (13) and Chuck (18).

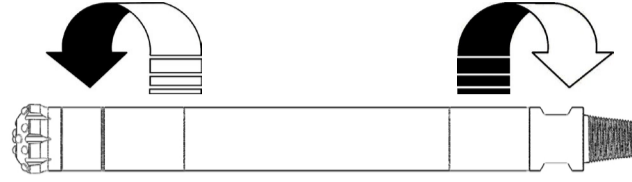

C. Unscrew and remove the Drill Bit, Chuck (18), Chuck Spacer (17) and Bit Retaining Ring (16) from Cylinder (13),.

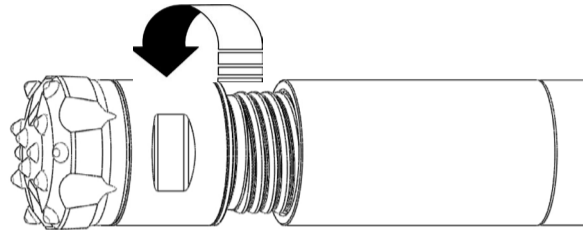

D. Remove Bit Retaining Ring (16) from the Drill Bit and the Chuck Spacer (17) from the Chuck (18).

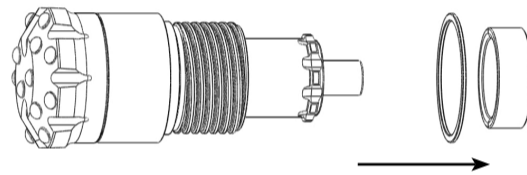

E. Remove the Chuck (18) from the Drill Bit.

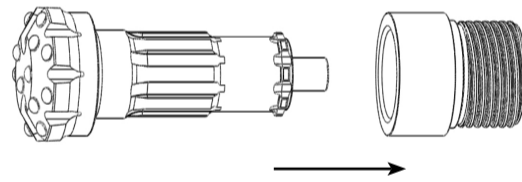

F. Remove Spacer (15) from Cylinder (13).

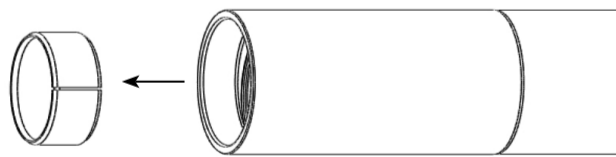

G. Remove Snap Ring (14) from the Cylinder (13) using the tools illustrated below.

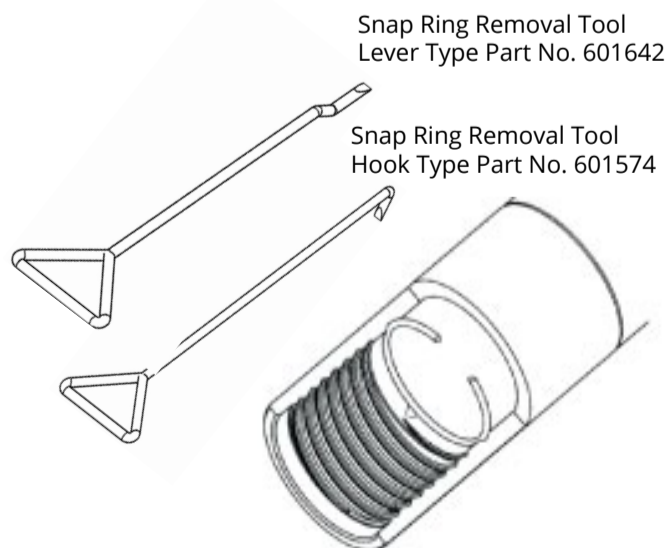

H. Remove Piston (14) from Cylinder (13).



I. Unscrew and remove Top Adaptor (2) from the Cylinder (13).

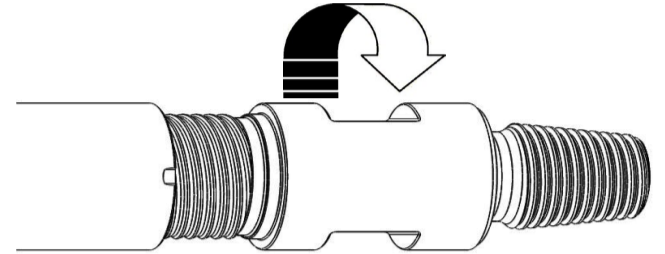

J. Remove 'O' Ring (3) from the Top Adaptor (2).

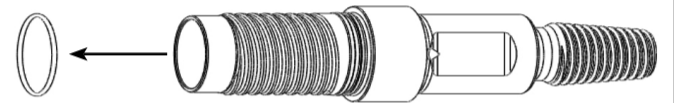

K. Remove the N.R.V. and Make Up Assembly (4-8).

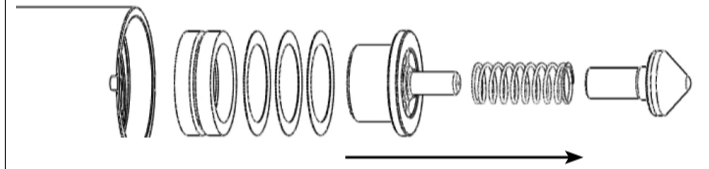

L. Remove Air Distributor (9) from the Cylinder (13).

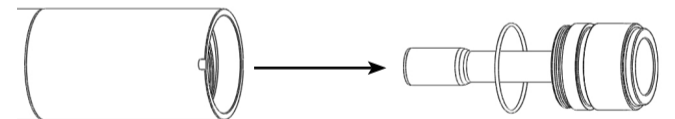

M. Remove Snap Ring (11) from the Cylinder (13) using illustrated tools.

Snap Ring Removal Tool
Lever Type Part No. 601642

Snap Ring Removal Tool
Hook Type Part No. 601574



DO NOT apply heat or direct impact to the outside of the hammer as this usually damages the equipment.



A. When dismantling hammers it is essential that cylinders are clamped into the correct position, away from threads, which can be damaged.



X & Y = DO NOT CLAMP HERE
X = 175 mm (6.889")
Y = 300 mm (11.811")

If you need further assistance, please call us on:
(0)1422 399900 or email salesuk@halcorocktools.com

HAJCO
Rock Tools